

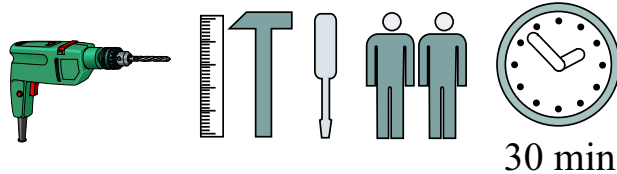

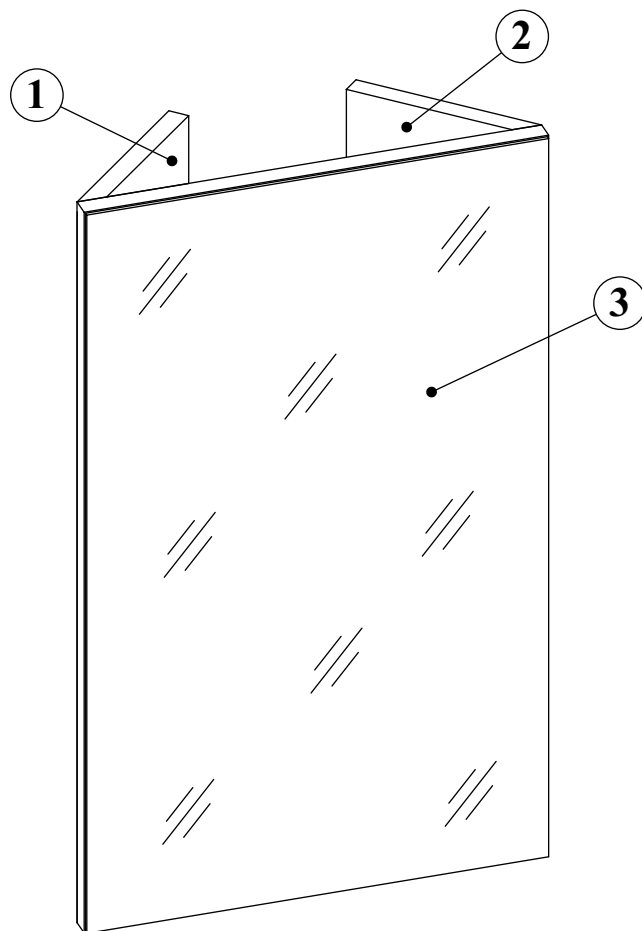



FINKA SL 841



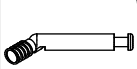

30 min

NO	Dim.		Col.-No	Qty
1	600	150	1	1
2	600	150	1	1
3	600	356	1	1

FINKA SL 841

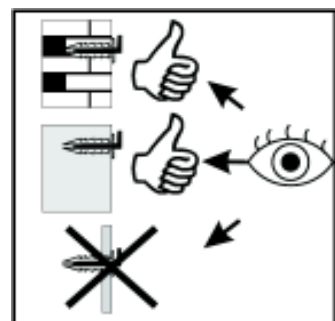
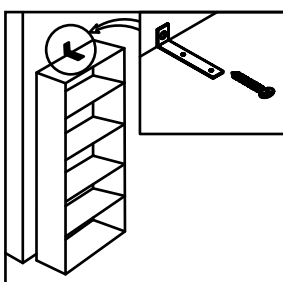
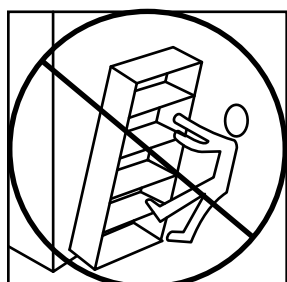
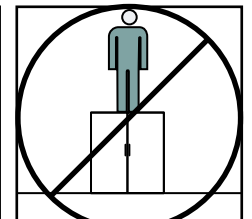
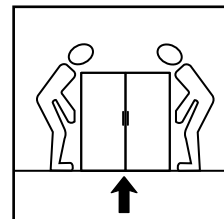
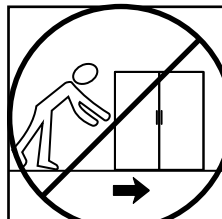
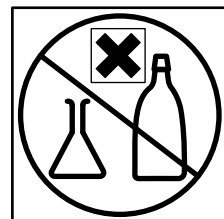
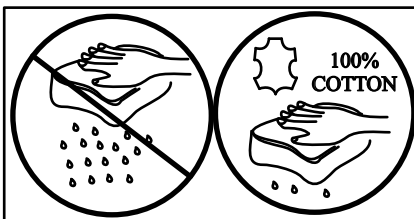
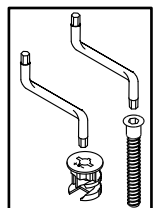
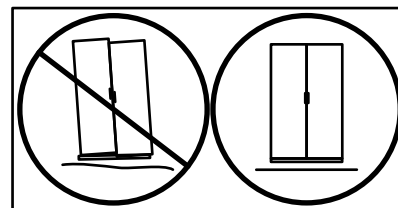
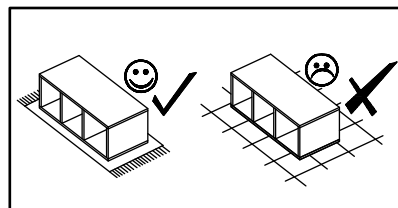
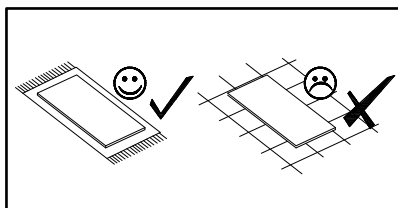
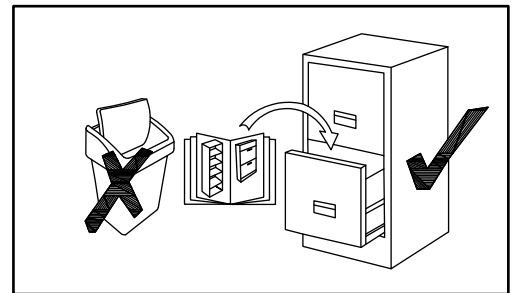
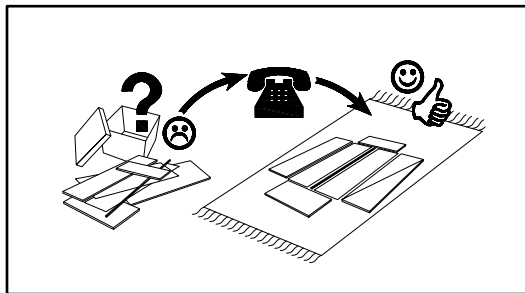
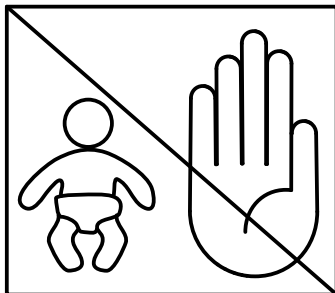
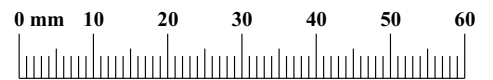
B5 x6	 ø15x12	B18 x6		G5 x6		ZM1 X2		D20 x4	 ESØ6x9,5	G2 x1	
----------	---	-----------	---	----------	---	-----------	--	-----------	---	----------	---

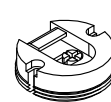

B5	
x6	ø15x12

ZM1	
x2	

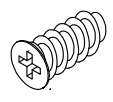
D20	
x4	ESØ6x9,5

1

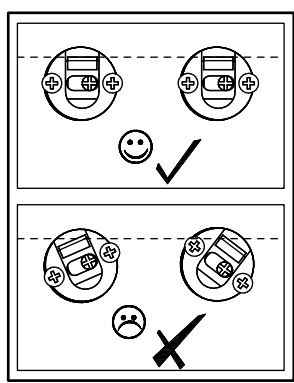
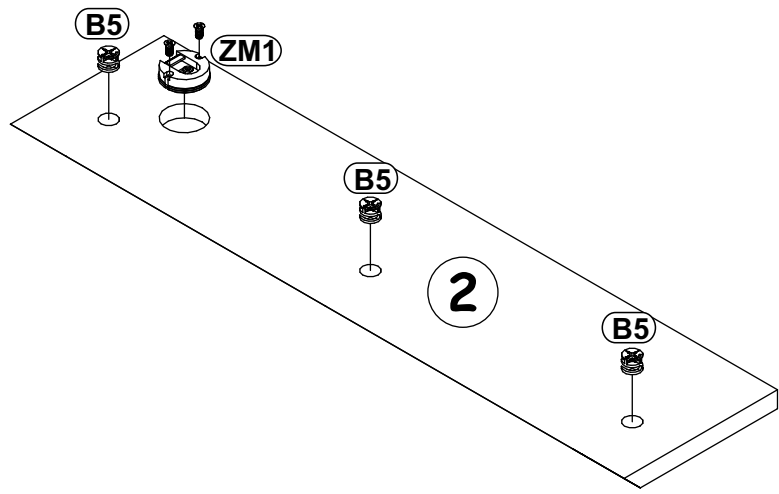
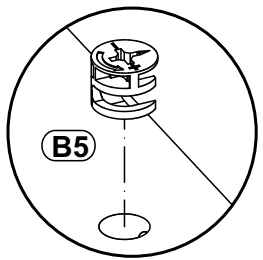
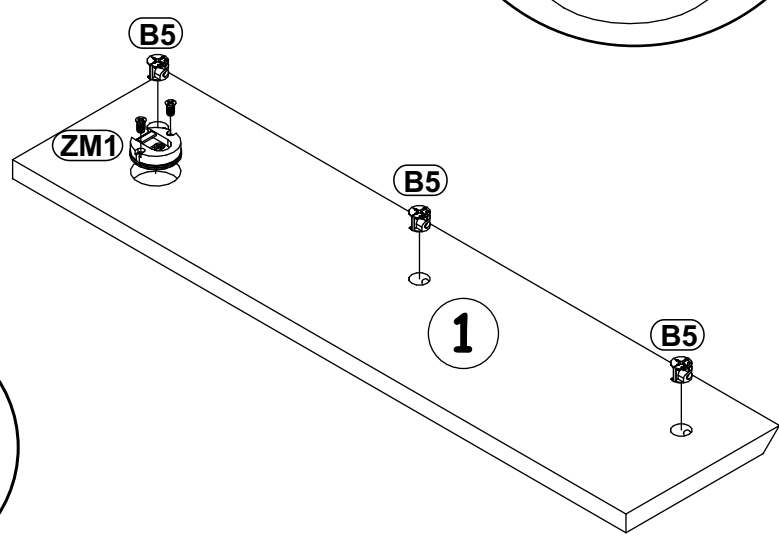
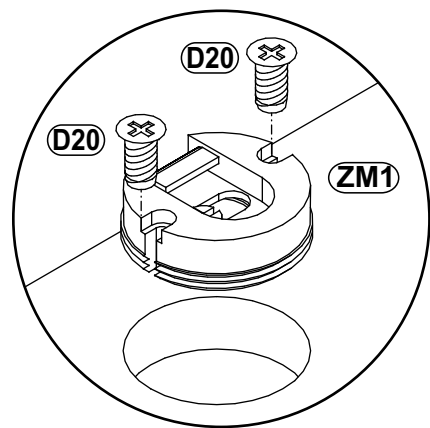

2

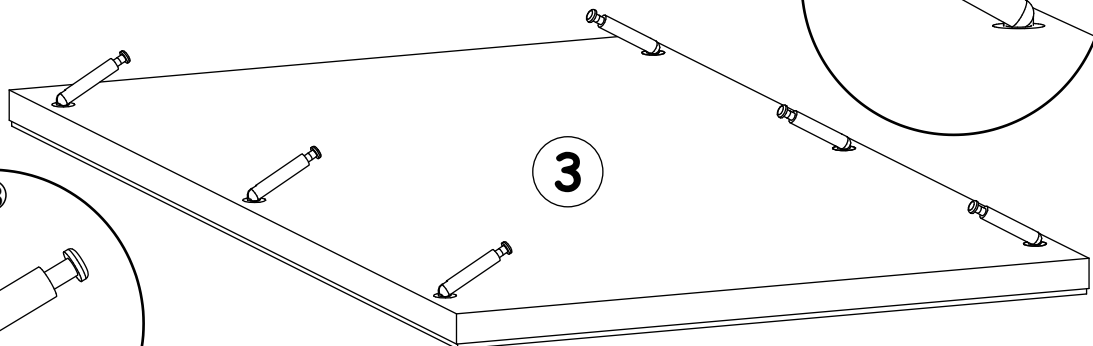
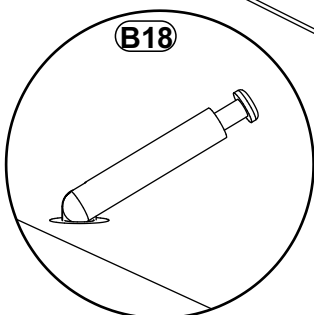
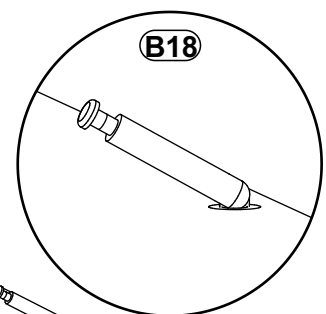
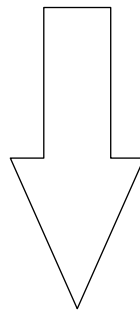
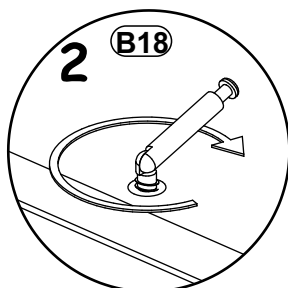
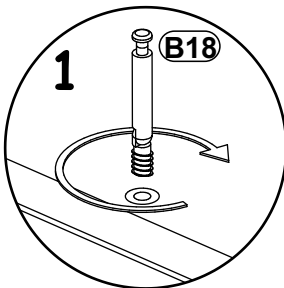
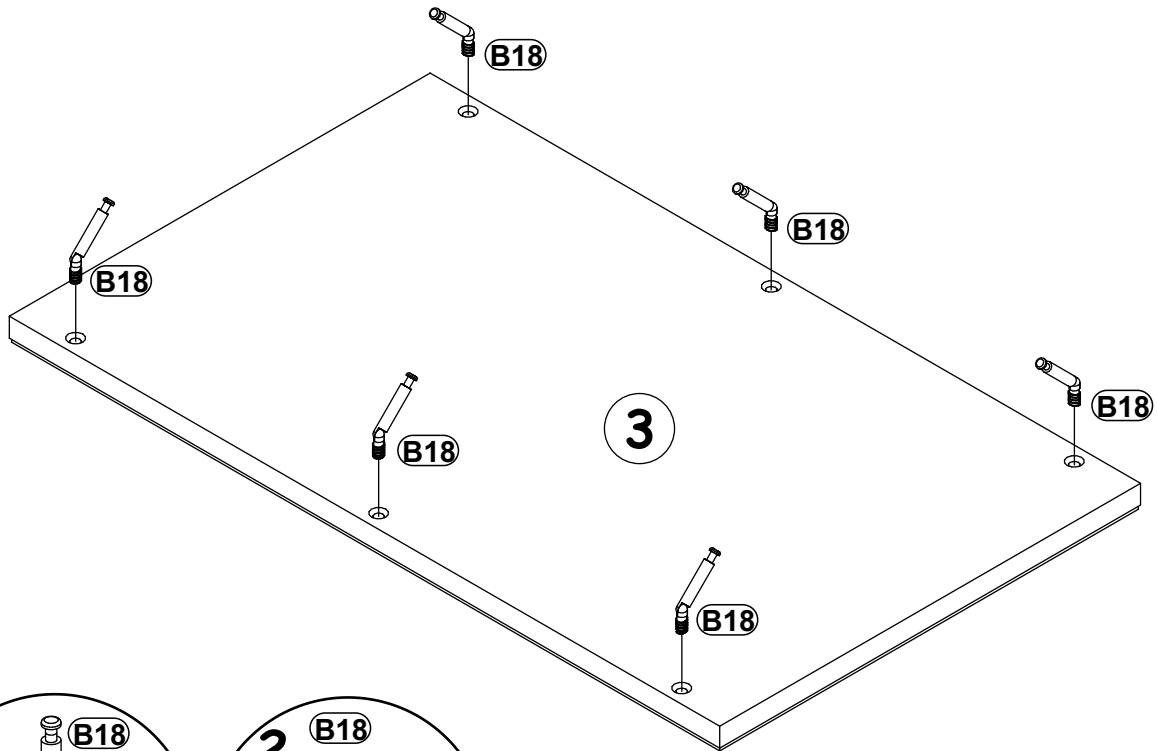
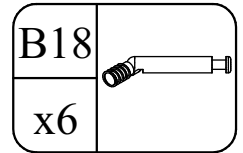
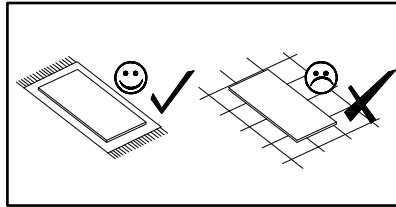

G5	
x3	

3

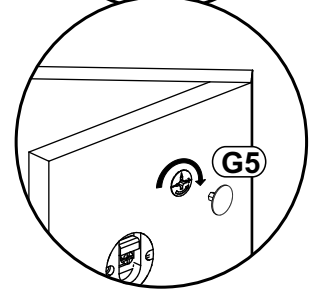
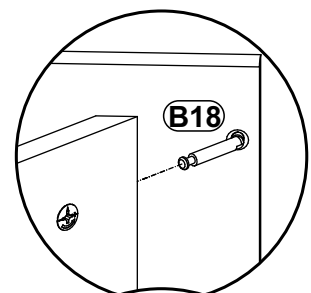
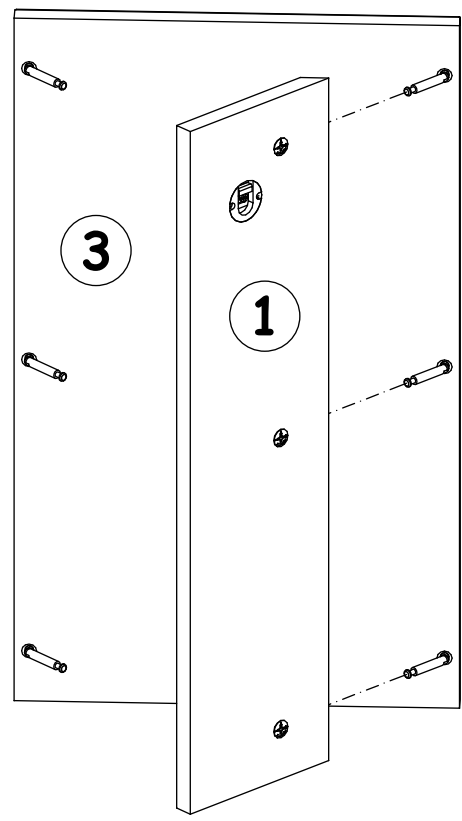

4

G5	
x3	

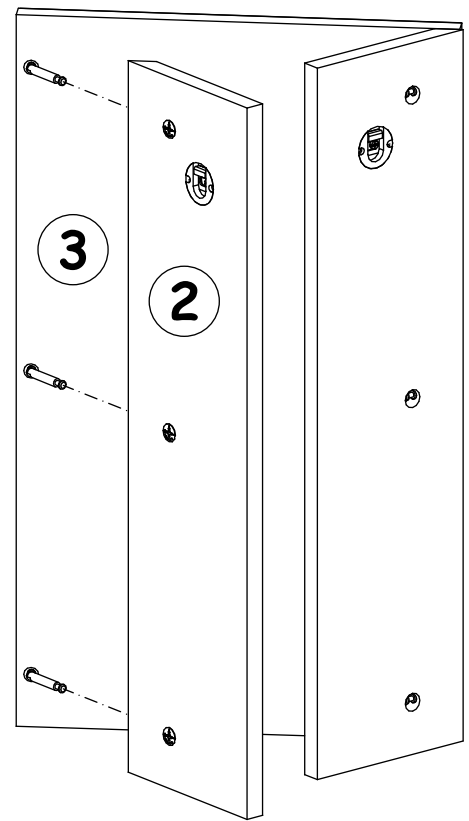
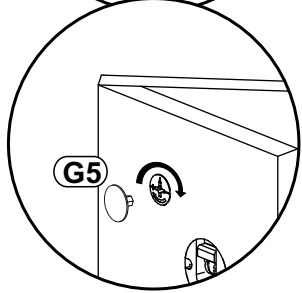
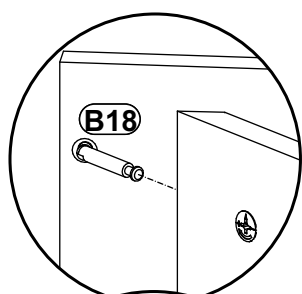

5

